

36. On a C (A2) size sheet make a two-view (one view can be a partial view) assembly drawing of the pipe cutter shown in Fig. 14-84. Sizes shown are nominal sizes. Include an item list and identification part numbers on the drawing. Scale 1:1.

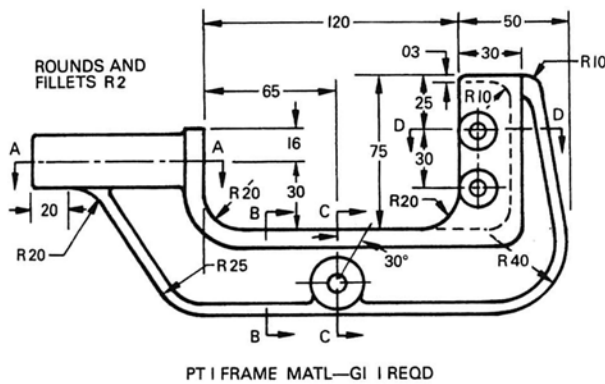

THREAD CONTROLLING ORGANIZATION AND STANDARD—ASME B1.13M-2001

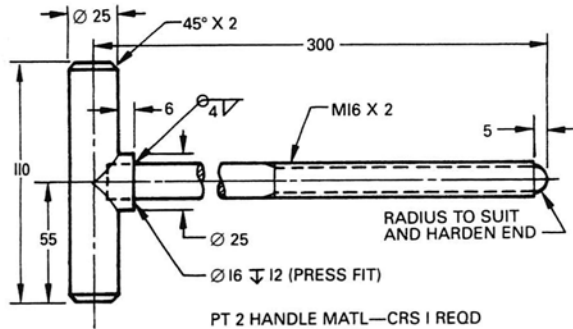
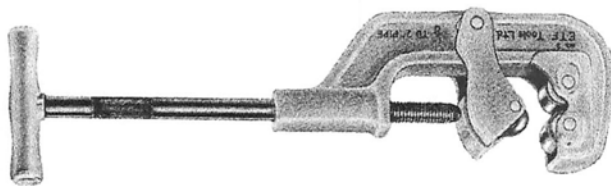
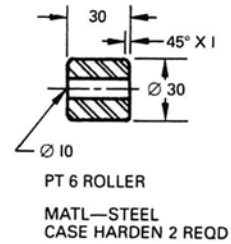
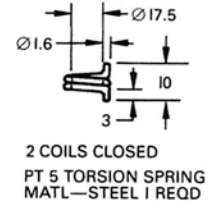
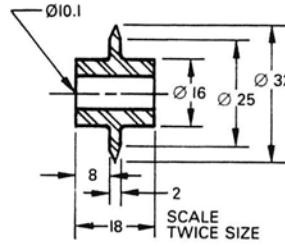

METRIC

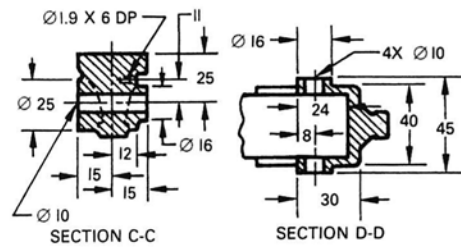
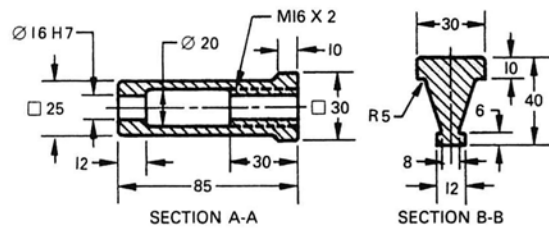
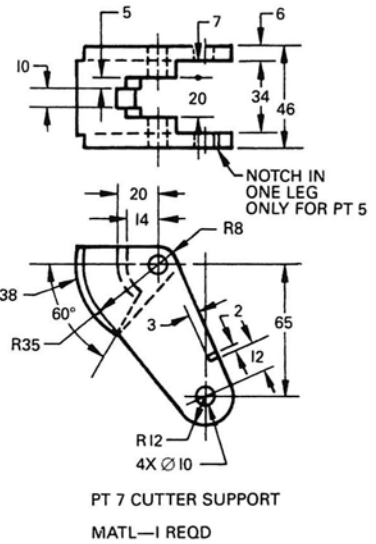
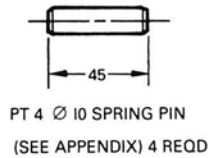

Fig. 14-84 Pipe cutter.